

Technical Handbook

CoinPower

Rechargeable Li-Ion Button Cells



Content

1.	GENERAL INFORMATION	3
1.1	Definitions	5
1.2	Features	6
1.3	Applications	7
1.4	General design and application criteria	8
1.5	Construction and electromechanical processes of CoinPower Batteries	9
2.	MISCELLANEOUS	10
2.1	Specification table VARTA CoinPower Batteries	11
2.2	Data-Matrix Code	12
3.	CHARGING AND DISCHARGING	14
3.1	Charging	15
3.2	Discharging	18
3.3	Charging IC	20
4.	RELIABILITY AND LIFE EXPECTANCY	21
5.	STORAGE	23
6.	SAFETY	25
6.1	Safety Tests	26
6.2	Product Safety	27
6.3	Protection Circuit Module (PCM)	28
7.	HANDLING PRECAUTIONS AND PROHIBITIONS	29
7.1	General Information	30
7.2	Charging	30
7.3	Discharging	31
7.4	Protection Circuit Module (PCM)	32
7.5	Application	32
7.6	Storage	33
7.7	Others subjects	33
7.8	Marking	36
8.	BATTERY ASSEMBLY	37
8.1	Single Cell Assembly	38
8.2	Multicellular Assembly	38
8.3	Soldering	38
9.	APPLICATION CHECK LIST	39
10.	GLOSSARY	41

1. General Information

1.1	Definitions	5
1.2	Features	6
1.3	Applications	7
1.4	General design and application criteria	8
1.5	Construction and electromechanical processes of CoinPower Batteries	9

General Information

VARTA Microbattery is a leading manufacturer of batteries and provides professional support worldwide to customers to help them to design VARTA batteries into their applications. Quality, reliability, high performance and customer satisfaction are the main reasons for our leading position in the market. VARTA Microbattery provides solutions to major OEM companies for high-tech applications such as Bluetooth headsets, activity trackers, heat cost allocator devices, back-up for memory and the real-time clock in PCs/notebooks as well as alarm systems, medical equipment, consumer electronics and many more product types.

VARTA Microbattery produces all major chemistries in various form factors. We are fully equipped to produce customized batteries. We are confident that we can provide an optimized battery solution for most application requirements.

Product Highlights of VARTA CoinPower Batteries

- Multiple patented innovations
- Wide capacity range
- Low internal resistance
- For discharge currents up to 3C
- Fast charge capability: ready to go in 15 min.
- Long life expectancy
- Excellent charge & discharge characteristics
- Safe & reliable (UL and IEC recognition)
- Smaller designs and lighter products for increased user comfort
- Produced on highly automated production lines in Germany

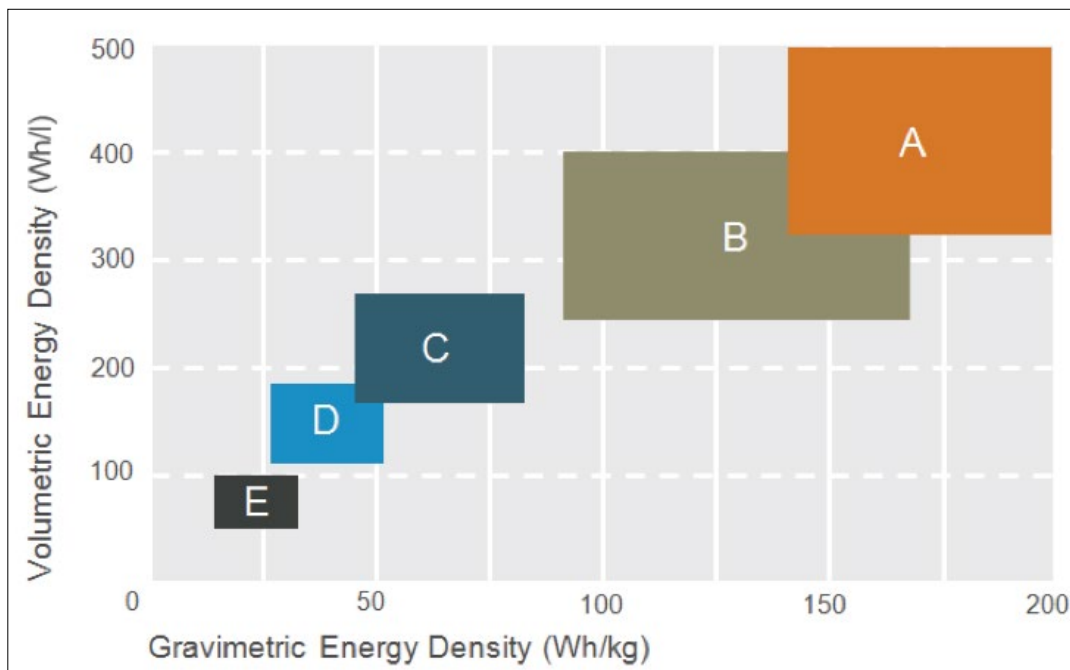

Comparison of the energy density of various rechargeable battery systems:
 A = Lithium Polymer
 B = Lithium-Ion
 C = Ni-MH
 D = Ni-Cd
 E = Lead acid

Comparison of different rechargeable battery systems

1.1 Definitions

Unless otherwise stated, specified values are valid for operation at room temperature $20\text{ }^{\circ}\text{C} \pm 3\text{ }^{\circ}\text{C}$.

Specific Data

The gravimetric energy density of the Li-Ion Coin Power series depends on battery size, and reaches up to 190 Wh/kg. Volumetric energy density ranges up to 500 Wh/L.

Voltage Definitions

Open Circuit Voltage (OCV):

Equilibrium potential 3.0 V to 4.3 V on average, dependent on temperature, storage duration and state of charge. Nominal Voltage of Li-Ion cells is 3.7 V

End of Discharge Voltage (EOD):

The voltage at the end of discharging is nominally 3.0 V per cell, but depend on discharge rate and temperature.

End of Charge Voltage: (EOC)

Terminal voltage after charge is 4.3 V.

Capacity Definitions

The capacity C of a cell is defined by the discharge current I and the discharge time

$$t: C = I \cdot t$$

I = constant discharge current

t = duration from the beginning of discharge until the end of discharge voltage is reached

Nominal Capacity

The nominal capacity C denotes the energy amount in mAh (milli-Ampère hours) that the cell can deliver at the 5 hour discharge rate (0.2 CA). The reference temperature is $+20\text{ }^{\circ}\text{C} \pm 2\text{ }^{\circ}\text{C}$, and the final discharge voltage is 3.0 V.

Typical Capacity

The typical capacity is the average capacity at a discharge rate of 0.1 CA to a final discharge voltage of 3.0 V.

Available Capacity

Li-Ion cells deliver their nominal capacity at 0.2 CA. This assumes that charging and discharging is carried out as recommended. Factors which affect the available capacity are:

- Rate of discharge
- End of discharge voltage
- Ambient temperature
- State of charge
- Age
- Cycle history

At higher than nominal discharge rates the available capacity is reduced.

Current Definitions

Charge and discharge rates are given as multiples of the nominal capacity (C) in Amperes (A) with the term CA.

Example:

Nominal capacity $C = 1000\text{ mAh}$

0.1 CA = 100 mA, 1 CA = 1000 mA

Nominal Discharge Current

The nominal discharge current of a Li-Ion cell is the 5 hour discharge current (0.2 CA).

It is the current at which the nominal capacity of a cell is discharged in 5 hours.

1.2 Features

VARTA CoinPower batteries are the first choice for a number of modern high-tech portable products. They provide a long lasting, reliable main power source which is lightweight and occupies a minimum of space in the host device.

VARTA CoinPower batteries meet the most important design requirements of these products:
Reliable high-power output, design flexibility with a minimum of space requirement and a round form factor.

Feature

- High energy density
- Wound electrode design
- Built-in safety device with chemical safety components
- Fully automated production in Germany
- Worldwide branch offices with technical support

Advantage

- Lightweight and small size
- High discharge currents
- The market's best safety performance
- High reliability and consistent quality
- Close customer relationship

Customer Benefit

- Best performance and long battery life
- Suitable for applications with high peak currents
- Additional cell protection in case the electronic circuit malfunctions
- high reliability in the field
- Local contact, local knowledge, local language

1.3 Applications

VARTA CoinPower batteries are especially suitable for modern electronic applications such as **Bluetooth Mono/Stereo Headsets, Sensors for Fitness/Sport/Healthcare, Smart Watches, Wearable Technology, Smart Car Keys** and many more. These cells are the ultimate power source for your electronic devices and make your products smaller, lighter and more attractive. VARTA CoinPower provides outstanding performance and reliability, excellent quality along with very safe operation.

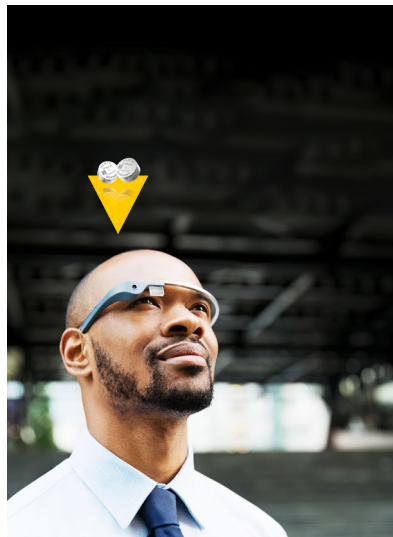

IOT

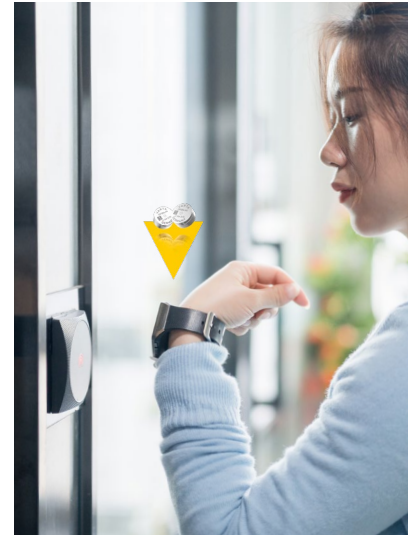

Smart Home



Medical



Automotive

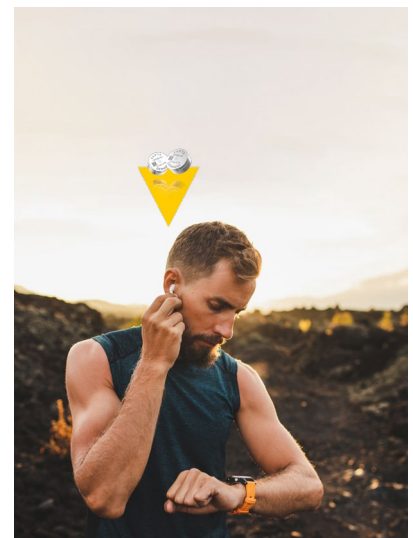

Wearables

1.4 General design and application criteria

Choose the most suitable battery from our range of VARTA CoinPower cells for the needs of your application and the conditions in which it is expected to operate. The most important criteria for the selection of battery type are these:

- Required minimum operating time
- Max. and average current drain
- Min. and max. operating voltage
- Operating temperature range
- Mechanical properties
- Available space
- Environmental conditions

You can choose a cell from the VARTA CoinPower range to operate within the following limits:

Operating Voltage: 3.0 V ... 4.3 V

Capacity: 28 mAh to over 200 mAh

Height: 4.0 mm, 5.0 mm and 5.4 mm

Diameter: 7.8 mm up to 21 mm

VARTA Microbattery's professional design-in team, available worldwide, will be happy to assist you with further recommendations and will guide you through the whole design and production process.



VARTA CoinPower production in Ellwangen/Germany

1.5 Construction and electromechanical processes of CoinPower Batteries

The housing of the CoinPower cells consists of two stainless steel parts. This gives the cell very high mechanical stability during assembly in the end-product as well as during the product's use by the customer. Inside the cell the anode, cathode and separator are wound to a coil. The connection of the electrodes to the housing is made by welding from the outside to the lid and cup. The innovative design of the housing, combined with its foil gasket, provides for the most efficient use of the space inside the cell for energy-storing material. This is why the energy density of the CoinPower batteries is one of the highest of any cell in this small form factor.

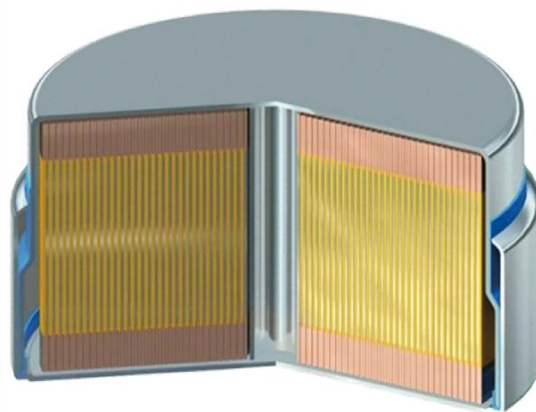

Construction of VARTA CoinPower

In Li-Ion batteries such as in the CoinPower cells Lithium ions move from the anode to the cathode during discharge and from the cathode to the anode when charging. Aluminum and copper are used for the positive and negative current collector. A liquid electrolyte provides for the movement of Lithium ions through the separator.

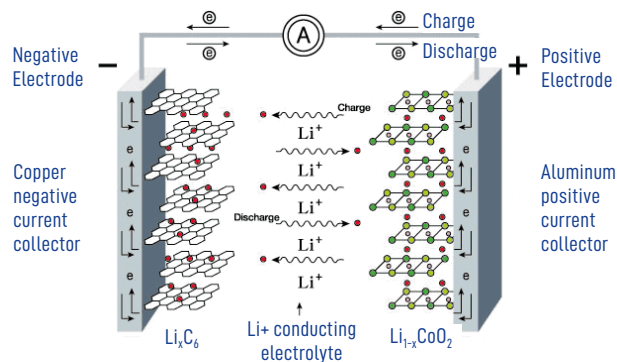

Chemical reaction in Li-Ion rechargeable battery

2. Miscellaneous

2.1	Specification table VARTA CoinPower Batteries	11
2.2	Data-Matrix Code	12

2.1 Specification table VARTA CoinPower Batteries

The CoinPower is available in three different chemistries, different diameters and 3 different heights.

Version	A	C	F
Technology	NMC	LCO	LFP
Nominal Voltage	3.7 V	3.8 V	3.3 V
Max. charging Current	2C	5C	0.5C

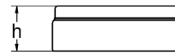
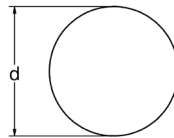

Cell diameters in the range of 7.8 mm up to 21 mm

Cell heights of 4.0 mm, 5.0 mm and 5.4 mm

Further designs on request

Model Number

The model numbers are two uppercase letters and a figure consisting of four digits.
The version number consists of one letter and one figure as shown in the example.

Model Number

CP1654 A4

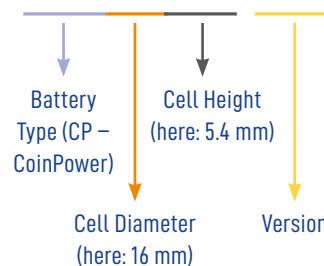

2.2 Data Matrix Code

In order to make every single cell fully traceable, two data matrix codes are printed on lid and cup of each one. This codes provide information about the production date, the version and the winder or assembly line.

Please note that the codes are printed on every individual cell produced in Germany. The battery code is different, and is indicated on the battery drawing.

Data Matrix Code cell diameter ≥ 10 mm

Data Matrix Code

0123789ABC1254A401



Data Matrix Code

01240740ABCD1254A401X

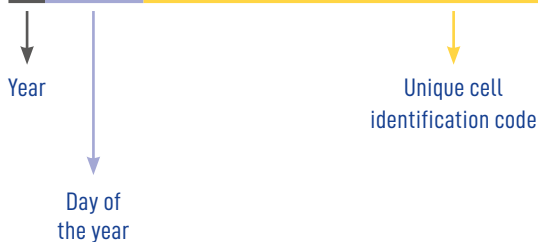

Data Matrix Code
cell diameter < 10 mm

Data Matrix Code

0123789ABC999

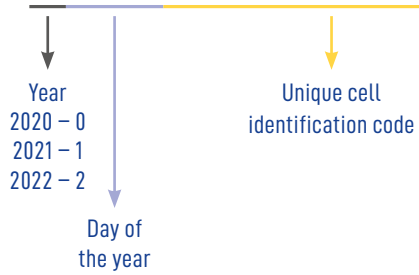

Date Code

0124010740

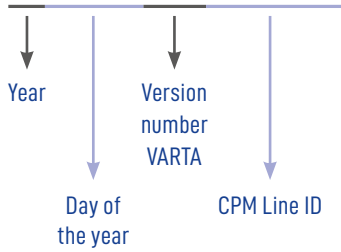

3. Charging and Discharging

3.1	Charging	15
	Specific Charging A-Version	
	Specific Charging C-Version	
	Specific Charging F-Version	
3.2	Discharging	18
	Specific Discharging A-Version	
	Specific Discharging C-Version	
	Specific Discharging F-Version	
3.3	Charging IC	20

3.1 Charging

The CoinPower Series can be charged with **different charging rates and procedures**. In order to find the best solution for the various applications please see the different options below. For more information please consult your Key Account Manager or the contact information in the foot line of this document.

CoinPower A3-Generation

Standard Charging

The CoinPower Series can be **standard charged** with a maximum **C-Rate of 0.5C** over the entire temperature range between 0°C and 45°C. The charging procedure must be Constant-Current Constant-Voltage (CCCV).

Fast Charging

The CoinPower Series can be **fast charged** with a maximum **C-Rate of 1C** over the entire temperature range between 0°C and 45°C. The charging procedure must be Constant-Current Constant-Voltage (CCCV). For this charging procedure the performance stated in the datasheet regarding capacity and cycle life may decrease.

Rapid Charging

Furthermore the cells can be **rapid charged** with a **two-step procedure**: **A charging rate of 2C can be applied up to max. 4.0V**, then continue with standard rate of 0.5C or fast rate of 1C until 4.2V. The charging voltages should be controlled within tolerances of ± 50 mV. The charging procedure must be Constant-Current Constant-Voltage (CCCV)

as well. The temperature range for the CC phase at **2C rate must be between 15°C and 45°C**. For this charging procedure the performance stated in the datasheet regarding capacity and cycle life may decrease.

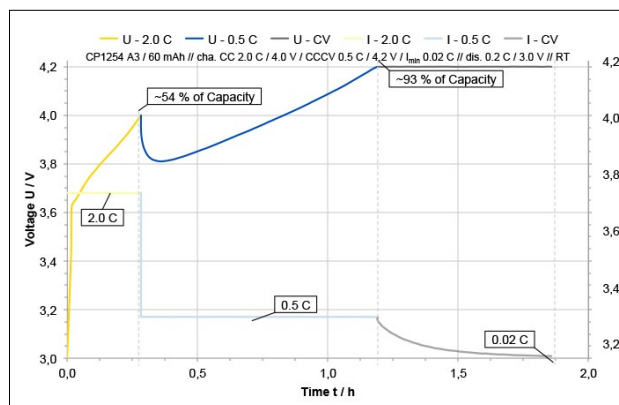

Charging Procedures Comparison

An overview about the different charging procedures with the related time and charged capacity can be found in the table below.

CHARGED CAPACITY	STANDARD CHARGE (0.5C)	FAST CHARGE (1C)	RAPID CHARGE (2C // 4.0 V - 0.5C // 4.2 V)
25 %	35 min	15 min	8 min
50 %	65 min	30 min	15 min
75 %	95 min	45 min	50 min
100 %	165 min	105 min	100 min

Data may vary due to temperature, age of cell and accuracy of voltage and current.

CoinPower A4-Generation

Standard Charging

The CoinPower Series can be **standard charged** with a maximum **C-Rate of 0.5C** over the temperature range between 15°C and 45°C. The charging procedure must be Constant-Current Constant-Voltage (CCCV).

Fast Charging

The CoinPower Series can be **fast charged** with a maximum **C-Rate of 1C** over the temperature range between 15°C and 45°C. The charging procedure must be Constant-Current Constant-Voltage (CCCV).

Rapid Charging

Furthermore the cells can be **rapid charged** with a **two-step procedure**:

A charging rate of 2C can be applied up to max. 4.0V, then continue with standard rate of 0.5C until 4.3V. The charging voltages should be controlled within tolerances of ± 50 mV. The charging procedure must be Constant-Current Constant-Voltage (CCCV) as well. The temperature range for the CC phase **at 2C rate must be between 20°C and 45°C**. For this charging procedure the performance stated in the datasheet regarding capacity and cycle life may decrease.

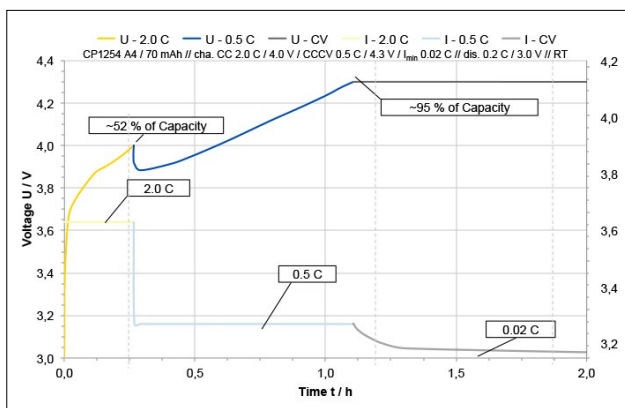

Low Temperature Cycling

To ensure the longest product lifetime and highest product performance at temperatures between 0°C and 5°C a maximum charging current of 0.1C can be applied. Between 5°C and 10°C the maximum charging current is limited to 0.2C whereas between 10°C and 15°C the maximum charging current can be raised up to 0.4C.

Charging Procedures at different Temperatures

An overview about the different charging procedures at different temperatures is shown below. The charging method always has to be Constant-Current Constant-Voltage.

TEMPERATURE	MAX. CHARGING CURRENT	AVERAGE CHARGING TIME
0°C < x < 5°C	0.1C	600 min
5°C ≤ x < 10°C	0.2C	290 min
10°C ≤ x < 15°C	0.4C	160 min
15°C ≤ x < 45°C	1C	135 min
20°C ≤ x < 45°C	1C	135 min
	2C up to 4.0 V, then 0.5 C	130 min

Data may vary due to age of cell and accuracy of voltage and current.

Charging Procedures Comparisons

An overview about the different charging procedures with the related time and charged capacity can be found in the table below.

CHARGED CAPACITY	STANDARD CHARGE (0.5C)	FAST CHARGE (1C)	RAPID CHARGE (2C // 4.0 V - 0.5C // 4.3 V)
25 %	30 min	15 min	8 min
50 %	60 min	30 min	12 min
75 %	90 min	45 min	45 min
95 %	120 min	55 min	70 min
100 %	165 min	135 min	130 min

Data at 20°C with cccv method and cut-off current of 0.02C.

C-Version

Applicable for all Types

The CoinPower C-Version can be charged with **different charging rates and procedures**. In order to find the best solution for the various applications please see the different options below. For more information please consult your Key Account Manager.

Standard Charging

The CoinPower C1-Version can be **standard charged** with a maximum **C-Rate of 0.5C** over the temperature range between 0 °C and 45 °C. The charging procedure must be Constant-Current Constant-Voltage (CCCV).

Fast Charging

The CoinPower C1-Version can be **fast charged** with a maximum **C-Rate of 3C** over the temperature range between 0 °C and 45 °C. The charging procedure must be Constant-Current Constant-Voltage (CCCV). For this charging procedure the performance stated in the datasheet regarding capacity and cycle life may decrease.

Rapid Charging

Furthermore the C1-Version can be **rapid charged with a two-step procedure: A charging rate of 5C can be applied up to max. 4.35 V**, then continue with standard rate of 1C until 4.45 V. The charging voltages should be controlled within tolerances of ± 50 mV. The charging procedure must be Constant-Current Constant-Voltage (CCCV) as well. The temperature range for the CC phase **at 5C rate must be between 15 °C and 45 °C**. For this charging procedure the performance stated in the datasheet regarding capacity and cycle life may decrease.

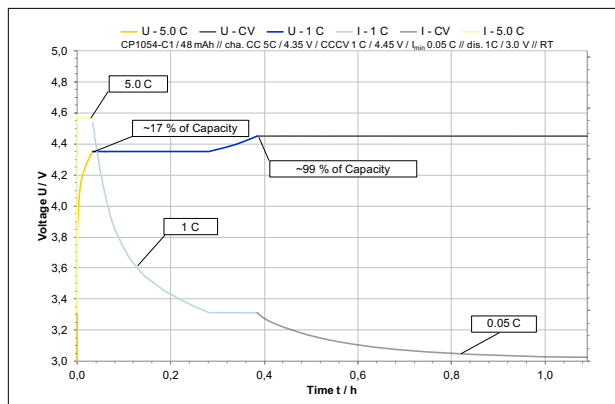

F-Version

Applicable for All Types

The CoinPower F-Version can be charged with VARTA Standard Charging.

Standard Charging

The CoinPower F-Version can be **standard charged** with a maximum **C-Rate of 0.5C** over the entire temperature range between 0 °C and 45 °C. The charging procedure must be Constant-Current Constant-Voltage (CCCV).

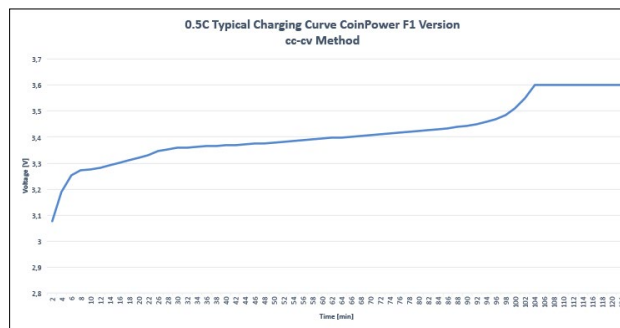

3.2 Discharging

A-Version

Thanks to its coiled electrode design the CoinPower series can handle very high discharge currents without any damage or reduction in cycle life while operating with a very low voltage drop. The cell can be discharged at **2C continuous and 3C in pulse mode for 2 s**. This makes it possible to run power-hungry devices and to support even high pulse load profiles. The supported discharge current can be even higher than 3C for shorter durations than 2 s.

Discharge Temperature

The cell should be discharged within a temperature range between -20 °C and 60 °C.

Over-Discharging

If not used for a long time, the cell(s) might become over-discharged. In order to prevent over-discharging, the cell(s) should be charged periodically to maintain a voltage in the range of 3.0 V to 3.8 V.

Over-discharging may cause some loss of cell performance or impair battery function. The host product should be equipped with a device which prevents further discharging below the cut-off voltage specified in the data sheet.

Important: The PCM over-discharge detection threshold/voltage must not be used as the cut-off voltage for the battery.

Also the charger shall be equipped with a device to control the recharging procedure as follows: In case of over-discharging, the cell(s) should be charged with a low current (0.01–0.07C) for 15–30 minutes, i.e. pre-charging, before standard charging starts. Charging according to the data sheet should be started after the individual cell voltage has risen above about 3.0 V and within 15–30 minutes. This timing can be controlled by the use of an appropriate timer for pre-charging.

If the individual cell voltage does not rise to about 3.0 V within the pre-charging time, the charger should be able to stop charging and display a notification that the cell(s) is/are in an abnormal state. In case the individual cell voltage falls below 2.0 V PCM shall have functions to disconnect the cell(s) from electronic circuit and cell shall not be recharged in any case.

Discharging Performance

The graphs below show the discharge curves of all three cell sizes of the CoinPower series at various currents (C-rates) and temperatures. The discharge capacity can be determined when the colored lines reach the 3.0 V level (End-of-Discharge Voltage). In every header there is detailed information about the discharge procedure. The second graph in each example shows the discharge performance at a 0.2C-Rate at various temperatures (-20 °C to +60 °C).

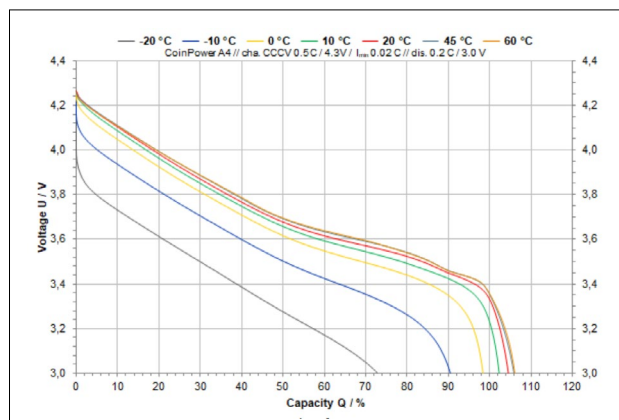
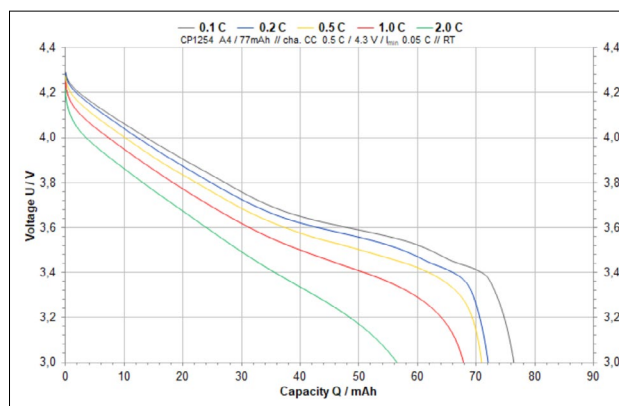

C-Version

The CoinPower C-Version can handle continuous discharge currents up to **5C** over the temperature range of -20 °C to 60 °C.

Discharge Temperature

The cell should be discharged within a temperature range between -20 °C and 60 °C.

Over-Discharging

If not used for a long time, the cell(s) might become over-discharged. In order to prevent over-discharging, the cell(s) should be charged periodically to maintain a voltage in the range of 3.0 V to 3.8 V.

Over-discharging may cause some loss of cell performance or impair battery function. The host product should be equipped with a device which prevents further discharging below the cut-off voltage specified in the data sheet.

Important: The PCM over-discharge detection threshold/voltage must not be used as the cut-off voltage for the battery.

Discharging Performance

The typical discharge characteristics of a CoinPower C-Version is shown in the graph below.

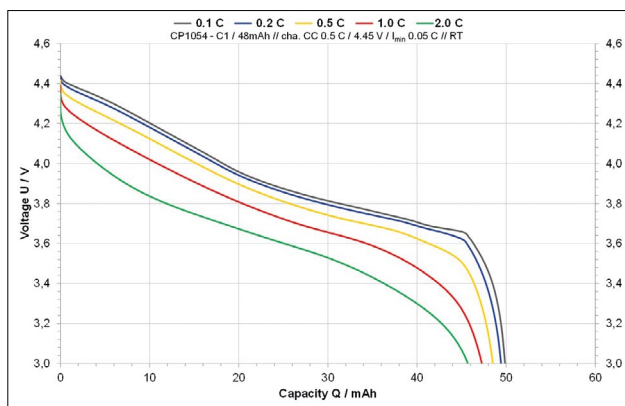

F-Version

The CoinPower F-Version can handle a maximum continuous discharge currents of **2C** over the temperature range of -20 °C to 60 °C.

Discharge Temperature

The cell should be discharged within a temperature range between -20 °C and 60 °C.

Over-Discharging

If not used for a long time, the cell(s) might become over-discharged. In order to prevent over-discharging, the cell(s) should be charged periodically to maintain a voltage in the range of 3.0 V to 3.8 V.

Over-discharging may cause some loss of cell performance or impair battery function. The host product should be equipped with a device which prevents further discharging below the cut-off voltage specified in the data sheet.

Important: The PCM over-discharge detection threshold/voltage must not be used as the cut-off voltage for the battery.

Discharging Performance

The typical discharge characteristics of a CoinPower C-Version is shown in the graph below.

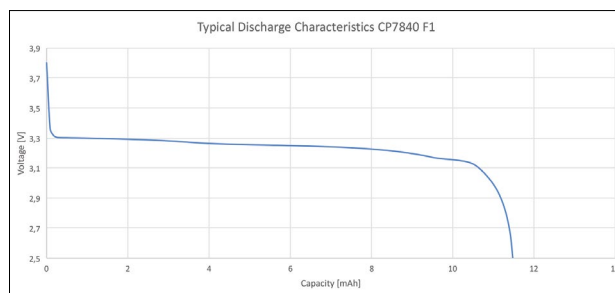

3.3 Charging IC

CoinPower batteries may be charged with any standard single-cell Lithium charging-IC which implements the CC/CV-procedure for Lithium systems.

Important: The charging current control have low level setting. The charging procedure can also be implemented by a microcontroller or DSP.

A Constant-current Constant-voltage (CC/CV) controlled charge system is used for charging Lithium and some other battery types that may be vulnerable to damage if the upper voltage limit is exceeded. The manufacturers' specified constant current charging rate is the maximum charging rate that the battery can tolerate without damaging the battery. Special precautions are needed to maximize the charging rate and to ensure that the battery is fully charged while at the same time avoiding overcharging. For this reason it is recommended that the charging method switches to constant voltage before the cell voltage reaches its upper limit. Note that this implies that chargers for Lithium-Ion cells must be capable of controlling both the charging current and the battery voltage.

Recommended charging ICs for VARTA CoinPower batteries:

Texas Instruments

- BQ 24040
- BQ 24050
- BQ 24052

Linear Technology

- LT 4070
- LT 4071

Please note: There are many more charging ICs available on the market for use in charging VARTA CoinPower batteries.

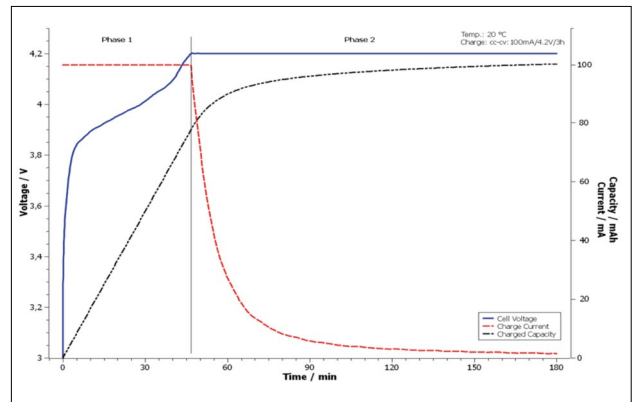

Illustrates the different phases during a charge cycle

4. Reliability and life expectancy

Reliability and life expectancy

VARTA CoinPower batteries provide outstanding cycle-life performance. All cell types have a cycle-life which is greater than 500 cycles with a remaining capacity of >80 % of its nominal value when new. Even at elevated temperature and higher discharge currents the VARTA CoinPower cells show excellent performance. This will provide extended battery life even after daily usage and in high consumption applications. The graphs show the discharge performance of the A4 Generation. For the other types the remaining capacity can be calculated by pro rata (see y-axis).

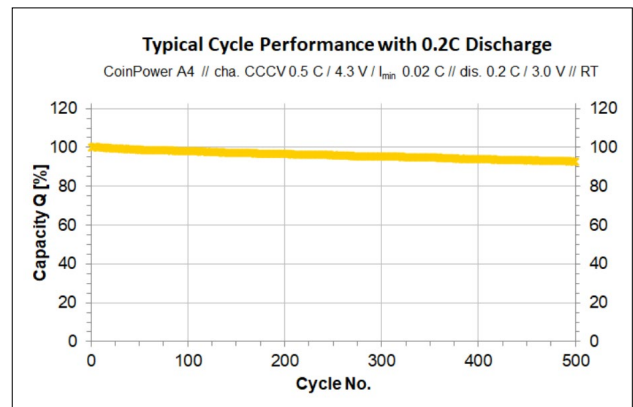
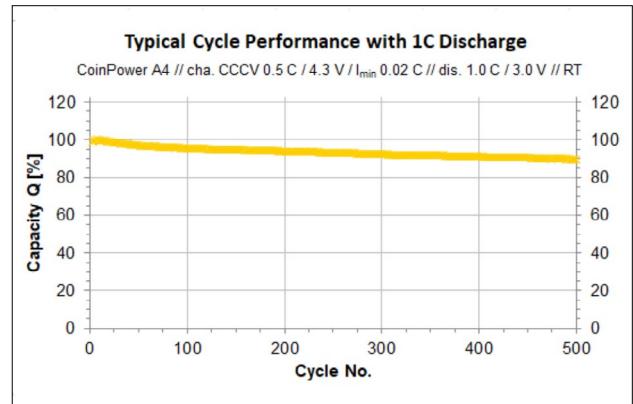

5. Storage

Storage

VARTA CoinPower batteries are delivered in a state-of-charge (SoC) of approximately 30 % of their full capacity. This provides the best condition for long-term storage at the lowest self-discharge rate. Higher temperatures increase the rate of self-discharge. It is recommended to store the cell at a state-of-charge between 30 % and 50 % at room temperature (20 °C) or lower.

The graph below shows the **storage characteristic** of a CoinPower cell after 6 months of storage at 20 °C and at 45 °C. When first going into storage, the cells had an SoC of approximately 30 %.

Since the self-discharge rate of the CoinPower cell is very low, cells may be stored for several months without periodic recharging. This offers convenience and flexibility for the owners of cells in stock as well as in the application for the end-user.

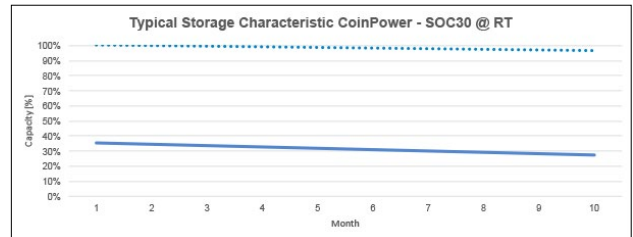

Storage Characteristic @ Various Temperatures Remaining Capacity

6. Safety

Product safety has always been a very important consideration for VARTA Microbattery. Besides all the technical features which give its high performance, the CoinPower series also provides the highest safety level in the market for small Lithium rechargeable batteries. In the following sections is more information about various safety features of the CoinPower series.

6.1	Safety Tests	26
6.2	Product Safety	27
6.3	Protection Circuit Module (PCM)	28

6.1 Safety Tests

Safety Tests

The CoinPower is certified for the three main safety standards which are applicable to rechargeable Lithium batteries. Below are more details about the various safety tests which are performed to verify a battery's compliance with the requirements of each of the three standards. VARTA Microbattery regularly performs additional safety tests in order to ensure the high safety level of the CoinPower series.

UL 1642

UL (Underwriters Laboratories) Standard for Safety for Lithium batteries. These requirements cover primary and secondary Lithium batteries for use as power sources in products.

IEC 62133

Secondary cells and batteries containing Alkaline or other non-acid electrolytes – safety requirements for portable sealed secondary cells, and for batteries made from them, for use in portable applications.

UN IATA 38.3

Transport regulations for air shipment for Lithium batteries according to section 38.3 of the UN Manual of tests and criteria published by the United Nations.

NO	TEST ITEM	UL 1642	IEC 62133	UN38.3	VARTA INTERNAL TEST
1	Short Circuit Test (at 20°C)	✓	✓		✓
2	Short Circuit Test (at 55°C)	✓		✓	✓
3	Abnormal Charging Test	✓	✓	✓	✓
4	Forced discharge	✓	✓	✓	✓
5	Crush Test	✓	✓	✓	✓
6	Impact Test	✓			✓
7	Shock Test	✓	✓	✓	✓
8	Vibration Test	✓	✓	✓	✓
9	Heating Test	✓			✓
10	Temperature Cycling Test	✓	✓	✓	✓
11	Altitude Simulation Test	✓	✓	✓	✓
12	Projectile Test	✓			✓
13	Continuous low rate charging		✓		✓
14	Free Fall, Drop Test		✓		✓
15	Thermal abuse		✓		✓
16	Overcharge 12 V/3C				✓
17	Overcharge 5 V/1 A				✓

Additional certifications for China: GB 31241 and UN 38.3.

6.2 Product Safety

The CoinPower Series provides for very safe operation. Safety features in the components used in the CoinPower battery, as well as in its mechanical design, ensure that the CoinPower cell will be safe even when subject to severe abuse conditions.

Venting Holes

The cup of every CoinPower battery is designed with three venting holes around the circumference. (every 120°)

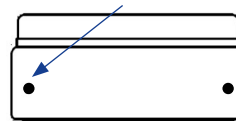

In the normal state these venting holes are covered by the foil gasket on the inside. When subject to abuse (e.g. continuous overcharging) the lid will lift up and excessive pressure can be released through these holes. This mechanism will prevent the cell from overheating and bursting when subject to severe overcharging.

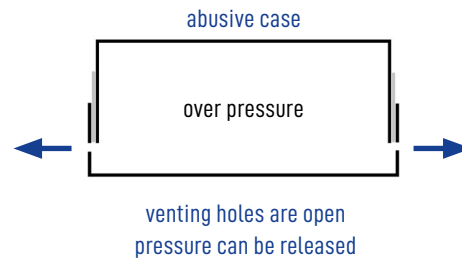
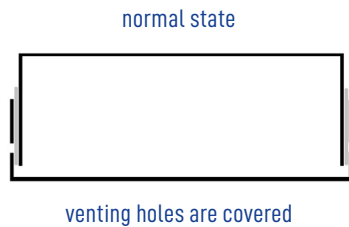

6.3 Protection Circuit Module (PCM)

The Protection Circuit Module (PCM) is a device to protect a battery against the risk of abnormal events such as over-discharging or short circuits. This is mandatory for all Lithium cells.

A PCM is not only used to protect the cells and applications from excessive discharge and recharge current, but also to maintain the nominal operating conditions for the cell and battery pack.

A CoinPower battery must be operated with a PCM which provides the following protection functions:

- **Over-charge protection**
- **Over-discharge protection**
- **Over-current protection**
- **Short circuit protection**
- **Optional additional functions: Over-temperature protection, ESD protection, Code identification, Power management, Fuel gauge**

Safety Tests

Recommended PCM for CoinPower Series:

- SG Micro (SGM41100V)
- Ricoh (R5613L)

Other suitable PCM:

- Seiko (S8211CAY, S8200A)
- Mitsumi (MM3077 LY, MM2511 K56)
- Texas Instruments (BQ 29700, BQ 29707)
- Diodes (AP9211)

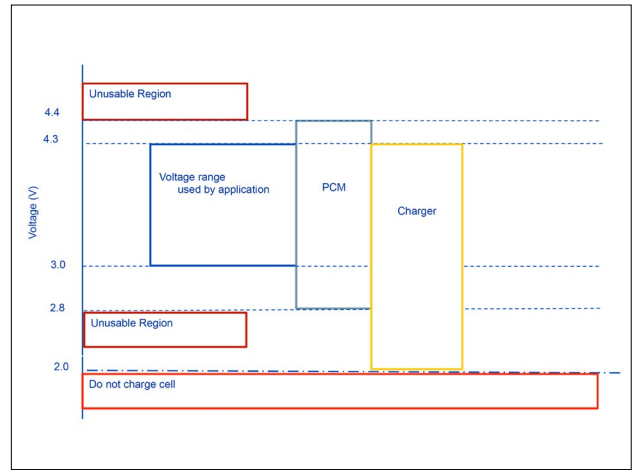

Voltage range for PCM and Charger for CoinPower A4 series

The schematic for using a PCM for the CoinPower is quite simple, just a few external components are necessary to build a fully functional safety circuit. Below is an example for the SEIKO 8211 CAY:

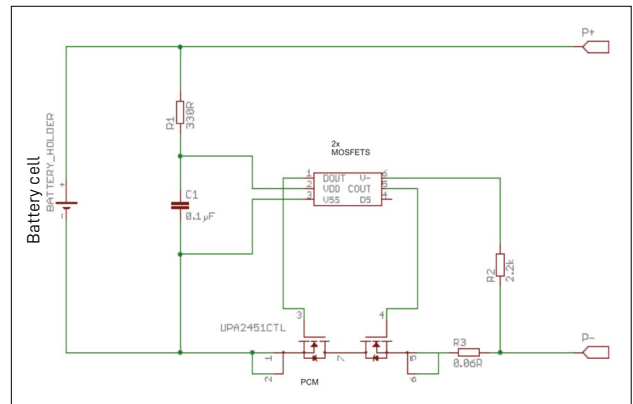

Example for the SEIKO 8211

7. Handling Precautions and Prohibitions

In this section there is information about the handling precautions and prohibitions for the VARTA CoinPower series. If you have any questions regarding any point please consult your Key Account Manager.

7.1	General Information	30
7.2	Charging	30
7.3	Discharging	31
7.4	Protection Circuit Module (PCM)	32
7.5	Application	32
7.6	Storage	33
7.7	Others subjects	33
7.8	Marking	36

7.1 General Information

Lithium batteries provide a high energy density which is often combined with a high rate capability to the benefit of the customer. Due to these excellent performance properties, Lithium batteries contain a certain safety risk. If short-circuited, heat and sometimes sparks may be generated. Mistreatment beyond the recommended limits can cause gas generation, leakage and fire.

This guideline „Handling Precautions, Prohibitions and General Supply Notices for VARTA Microbattery GmbH CoinPower Batteries“ shall be applied to VARTA CoinPower batteries. It shall be brought to the attention of all persons who handle the batteries.

The customer is requested **to contact VARTA Microbattery GmbH in advance**, if and when the customer needs other applications or operating conditions than those described in this document. In this case additional tests and experiments may be necessary to verify performance and safety under such conditions. VARTA Microbattery GmbH shall not be responsible for safety, performance, functionality, compatibility or fitness for a particular purpose unless such features have been expressly communicated and described in the specification.

VARTA Microbattery GmbH will take **no responsibility** for any accident when the cell is used under **other conditions than those described in this guideline**. VARTA Microbattery GmbH will inform, the customer in writing of improvement(s) regarding proper use and handling of the cell, if deemed necessary. Do not modify and or open cells or batteries without prior written approval by VARTA Microbattery GmbH.

Current version available under www.coinpower.de

7.2 Charging

Charging Current

Charging current should **not exceed maximum charge current** specified in the Data Sheet.

Charging with higher current than recommended may cause damage to cell performance and safety features, and can lead to **heat generation or leakage**.

Charging Voltage

Charging at above 4.3 V, which is the absolute maximum voltage, is strictly prohibited. The charging has to be done according to the data sheet. The charger shall be designed in accordance with this condition. Use specified charger only.

Charging with higher voltage than specified may cause damage to cell performance and safety features, and can lead to **fire, heat generation or cell leakage**.

Charging Temperature

The cell shall be charged within the range of specified temperatures in the Data Sheet. If the cell is charged at a temperature out of the specified range, **leakage, heat generation, or other damages may occur**.

Repeated charging and discharging at high and low temperature may cause degradation of cell performance even within the specified temperature range.

Prohibition of Reverse Charging

Reverse charging is prohibited. The cell shall be connected correctly. The polarity has to be confirmed **before connecting** any wires. Reverse charging will cause damage to the cell(s) and will lead to a loss of cell performance and cell safety (including heat generation or leakage).

Prohibition of Trickle Charging or Continuous Charging

Trickle charging or continuous charging is prohibited. Trickle charging conditions or continuous charging can lead to overcharging, generation of internal pressure and degeneration of the cell.

The cell shall be charged with constant current until $4.3\text{ V} \pm 50\text{ mV}$, then with constant voltage and tapering current. At approx. 0.02C current the charging must be stopped. Charging should restart only if appreciable capacity has been discharged from the cell, or the cell voltage has fallen itself below a voltage level of 4.0 V .

7.3 Discharging

Discharge Current

The cell shall be discharged at **less or equal than the maximum discharge current** specified in the Data Sheet. High discharge current may reduce the discharging capacity significantly, or cause **overheating**.

Discharge Temperature

The cell shall be discharged within the temperature range that is specified in the Data Sheet.

Over-Discharging

Not using the cell(s) for a long time may lead to over-discharge. In order to prevent overdischarging, the cell(s) shall be charged periodically to maintain a voltage in the range of 3 V to 3.8 V .

Over-discharging may cause loss of cell performance, or damage battery function.

The application device shall be equipped with a device to prevent further discharging below the **cutoff voltage** specified in the Data Sheet.

PCM over-discharge detection threshold/voltage must not be used as **cutoff voltage** for battery.

Also the charger shall be equipped with a device to control the recharging procedures as follows:

In case of over-discharging, the cell(s)/battery pack shall start with a low current ($0.01\text{--}0.07\text{C}$) for $15\text{--}30$ minutes, i.e. precharging, before rapid charging starts.

The charging according to the Data Sheet shall be started after the individual cell voltage has risen above about 3 V within $15\text{--}30$ minutes, which can be determined and controlled by the use of an appropriate timer for precharging.

In case the individual cell voltage does not rise to about 3 V within the pre-charging time, the charger shall have functions to stop the further continuous charging and display that the cell(s) is/are in an abnormal state.

7.4 Protection Circuit Module (PCM)

The cell(s) shall be provided with a **PCM** which can protect cell(s) properly, e.g. in case of failing Charge Control Circuit.

PCM shall have functions of (i) overcharging prevention, (ii) over-discharging prevention, and (iii) over current prevention, to maintain safety and prevent significant deterioration of cell performance. The overcurrent can occur by external short circuit.

Over-Discharge Prohibition

Over-discharge prevention function shall work to minimize dissipation current to avoid further drop in cell voltage below 2.0 V.

It is recommended that the dissipation current of PCM shall be designed to be minimized to 0.5 microamperes or less after the over-discharge prevention function activates in order to minimize effects on shelf life of the battery.

In case the individual cell voltage falls below 2.0 V, the cell shall be disconnected from electronic circuit and shall not be recharged in any case.

7.5 Application

For the batteries approved by UL (File MH13654) the intended use is at ordinary temperatures where anticipated high temperature excursions are not expected to exceed 70 °C. Nevertheless under reasonably foreseeable misuse conditions at temperatures up to 85 °C over 4 hours no safety risk occurs.

Technician-Replaceable Appliances

VARTA Lithium-Ion batteries of type CoinPower do not fulfill the requirements for being User replaceable, as the reverse polarity installation cannot be prevented. Therefore the VARTA Lithium Ion batteries of Type CoinPower can be used only in devices where servicing of the battery circuit and replacement of the Lithium battery will be done by a trained technician.

The instruction manual supplied with the end product shall contain the following warning notice:

- „Replacement of battery has to be done by trained technician. For replacement only batteries with (Battery Manufacturer's name or endproduct manufacturer's name), Part No. () may be used. Use of another battery may present a risk of fire or explosion.“
or
„The battery used in the (End Product Name) must be replaced at (End product manufacturers) service center only.“
- „Caution: The battery used in this device may present a fire or chemical burn hazard if mistreated. Do not disassemble, heat above 100 °C (212 °F) or incinerate.“
- „Dispose of used battery properly considering local laws and rules. Keep away from children – harmful if swallowed!“
- „WARNING: Risk of Fire, Explosion, and Burns. Do Not Disassemble, Crush, Heat above 100 °C (212 °F), Short-Circuit or Incinerate.“

7.6 Storage

Storage of cells

The cells shall be stored within a **proper temperature range** as specified in the Data Sheet. The state of charge shall be 30 % of the nominal capacity; open circuit voltage OCV about 3.6 V. When stored for a long time, care has to be taken that the battery voltage does not drop below the cut-off voltage due to self-discharge (see 7.3).

Storage of assembled cells in application

The assembled cells in application shall be stored within a **proper temperature range** as specified in the Data Sheet. When stored for a long time, care has to be taken that the battery voltage in application does not drop below the cut-off voltage due to self-discharge (see 7.3).

7.7 Other subjects

Cell Connection

Soldering or welding of wires or other types of connectors **directly to the cell** is strictly prohibited. A proper cell connection can only be done by the cell manufacturer itself. If soldering or welding of wires or other types of connectors directly to the cell will be done not by the cell manufacturer, all claims regarding warranty, performance and safety will be omitted.

Ultrasonic Welding of Application Housing

Ultrasonic welding of plastic lid to the plastic casing can be applied. However, the welding shall be done **avoiding the application of ultrasonic wave power directly to the cells**. Otherwise it may cause serious damage to the cells.

Prevention of Short-Circuit in Application

Enough **insulation layer(s)** between wiring and the cells shall be used to maintain multiple safety protection. The battery housing shall be designed to prevent short-circuits while cell is assembled and during usage of device. This is because short circuits may cause **generation of smoke or fire**.

Assembly

Important: Always avoid any possible contact of cell housing with sharp objects, corners, or points which could puncture or damage the cell.

Avoid applying mechanical stress (such as tension, pressure) to cell itself during assembly. Do not remove or disassemble any component from the original VARTA supply configuration.

Do not subject cell to higher temperatures than specified in Data Sheet provided.

Do not subject cell to ultrasonic weld process vibration or energy.

Avoid accidental short-circuit of cell during assembly and finishing processes.

Avoid accidental mechanical damage to cell during assembly and finishing processes.

Packaging for cell has to be made of insulating material, avoiding discharge or short-circuiting.

Prohibition of Disassembly

Never disassemble the cells.

Disassembling cells may cause an internal short-circuit in the cell, which could further **cause gassing, fire, or other problems.**

Harmful Electrolytes

An electrolyte which leaks out from the cells is harmful to the human body. If the electrolyte comes into contact with the skin, eyes or other parts of body, the electrolyte shall **be flushed immediately with water. Seek medical advice from a physician.**

Prohibition of Short-Circuit

Never short-circuit the cells. It causes generation of very high currents resulting in heating of the cells, which may cause electrolyte **leakage, gassing or fire.**

Prohibition of Dumping of Cells into Fire

Never incinerate nor dispose of cells into fire.

Prohibition of Cells Immersion into Liquid Such as Water

The cells shall never be soaked with liquids such as water, sea water, drinks such as soft drinks, juices, coffee or others.

Battery Cells Replacement

The battery replacement shall be done **only by device supplier** and never be done by the user.

Prohibition of Use of Damaged Cells

Cells may be damaged during shipping by shocks, or other causes.

If any abnormal features of the cells are found such as: damage to the stainless steel housing of the cell, deformation of the cell container, smell of electrolyte, an electrolyte leakage, or other abnormalities, the cells **shall not be used any more.**

Cells with a smell of electrolyte or leakage shall be kept away from fire to avoid **ignition.**

General Supply Notices and Responsibilities

The customer agrees to manufacture, assemble, sell, transport and/or dispose of the finished products in a way that the health and safety of people, including workers and general public, and environmental protection can always be assured. Customer agrees and guarantees to comply with any and all relevant safety and environmental requirements, laws and regulations in the countries where the Products are sold, manufactured, transported, stored or disposed.

The customer shall be solely responsible for health, safety and environmental matters arising from its manufacture, assembly, sales, use, transportation and/or disposal of the finished products, and shall defend, indemnify, and hold VARTA Microbattery GmbH, its subsidiaries, customers, and suppliers and its and their respective representatives and employees harmless from and against all costs, liabilities, claims, lawsuit, including but not limited to attorney's fees, with respect to any pollution, threat to the environment, or death, disease or injury to any person or damage to any property resulting, directly or indirectly, from the manufacture, assembly, purchase, sales, use, operation, transportation or disposal of the finished products; except to the extent that the customer shall be exempted from such obligation if and so long as the cause of such damage is attributable directly and solely to VARTA Microbattery GmbH.

Battery Compartment Design

Protection circuit shall be isolated from the cell to diminish damage from any electrolyte leakage which may occur by mishap. The battery compartment shall be designed not to allow leaked electrolyte access to protection circuit.

Battery case material resistance for electrolyte shall be considered when battery case material is selected.

Under abusive conditions the cell may vent. To ensure venting cell has venting holes in cup on the circumference of cell. Care has to be taken, that overpressure can be released in any abusive condition. Assembly must not interfere with venting mechanism.

Under abusive conditions the cell may vent; to ensure safe venting, up to 1.5 mm of additional space in axial direction is necessary. This can be ensured e.g. by deflection space in cell compartment or a predetermined breaking point.

Protection Circuit Module Design

Electrolyte has corrosive characteristics. Protection circuit module may not work correctly if exposed to electrolyte.

This should be considered in protection circuit module design. Main wiring patterns shall be separated from each other as much as possible.

Conductive patterns and connection terminals which may be short-circuited by electrolyte leakage should be separated from each other as much as possible. Another method is coating the whole surface of the module by conformal coating material.

Warning

The following warning language is to be provided with the information packaged with the small cells and batteries or equipment using them:

- Keep small cells and batteries which are considered swallowable out of the reach of children.

- Swallowing may lead to burns, perforation of soft tissue, and death. Severe burns can occur within 2 h of ingestion.
- In case of ingestion of a cell or battery, seek medical assistance promptly.

Guideline for safe handling

Always follow the warning information on the batteries and in the manuals of devices. Only use the recommended battery types. Keep batteries away from children. Keep small cells and batteries which are considered swallowable out of the reach of children. For devices to be used by children, the battery casing should be protected against unauthorized access. Unpacked batteries shall not lie about in bulk. In case of battery change always replace all batteries by new ones of identical type and brand. Do not swallow batteries. Swallowing may lead to burns, perforation of soft tissue, and death. Severe burns can occur within 2 h of ingestion. In case of ingestion of a cell or battery, seek medical assistance promptly. Do not throw batteries into water. Do not throw batteries into fire. Avoid deep discharge. Do not short-circuit batteries. Use recommended charging time and current. Do not open or disassemble batteries.

Supply to private end users

In case the products are supplied to private end users packed with equipment or contained in equipment it is strongly recommended to follow UL product and instruction manual requirements. The product is required to be marked with a graphical symbol that alerts the user to refer to the instruction manual. The instruction manual itself is required to contain

- an attention word, such as "Caution", "Warning", or "Danger",
- a brief description of possible hazards associated with mishandling of the battery, such as burn hazard, fire hazard, explosion hazard,

7.8 Marking

- a list of actions to take to avoid possible hazards, such as "do not crush, disassemble, dispose of in fire", or similar actions,
- instructions regarding replacement batteries if the batteries are replaceable by the user,
- a warning marking with text to alert the user of the potential chemical burn hazard associated with coin/button battery ingestion,
- an instruction as to the presence of a coin/button cell battery,
- possible effects of battery ingestion,
- an instruction to keep batteries away from children, and
- an advice to seek immediate medical attention if it suspected that batteries have either been swallowed or placed inside any part of the body.

A lithium-ion battery pack shall be marked with the following or equivalent: "CAUTION: Risk of fire and burns. Do not open, crush, heat above manufacturer's specified maximum temperature or incinerate. Follow manufacturer's instructions".

Further advice for parents:

<http://buttonbatterysafety.com>

<http://www.productsafety.gov.au/news/>

[the-battery-controlled-button-battery-safety](http://www.productsafety.gov.au/news/the-battery-controlled-button-battery-safety)

The customer shall prepare comprehensive instructions and appropriate markings for end users. The assembled device shall be provided with **packing, handling and safety instructions** regarding cell usage, storage, and replacement, and shall be marked with information in accordance with applicable regulations. **The prohibitions mentioned in this document, regulations in UL 1642 (and other specifications) shall be clearly explained to the users.**

The markings shall also be done in accordance with requirements based on guidelines for rechargeable Lithium Ion batteries for maintaining safety of the cells.

Example for marking according to the UL 1642 regulation:

Mark the manufacturer's name, business name or trademark, and specified model name.

Use the word „Warning" and indicate the statement "Risk of Fire, Explosion, and Burns. Do Not Disassemble, Crush, Heat Above 100°C (212°F), Short-Circuit or Incinerate" or equivalent.

Final product shall be marked with following statement or equivalent: „Replacement may only be made with cell specified by the final product manufacturer, with correct Part Number. Fire or burning may occur if the customer uses cell other than specified by the final product manufacturer. The customer shall refer to the handling instruction issued by the final product manufacturer."

If it is not possible to mark the warnings mentioned above on the final products, the final product manufacturer shall mark and print the warnings in the handling or maintenance instructions or manuals of the products.

Especially the marking shall contain the advices in chapter 4 according to the type of usage.

8. Battery Assembly

Besides the bare cells, VARTA Microbattery provides customized solutions for all kinds of battery assembly in order to meet customers' individual requirements. VARTA can offer many different cell configurations together with the necessary connections such as wires and tags. Multicell assembly is possible as well.

8.1	Single Cell Assembly	38
8.2	Multicellular Assembly	38
8.3	Soldering	38

8.1 Single Cell Assembly

For some applications, a bare cell is not the ideal solution for connecting the battery to the PCB. Therefore VARTA Microbattery offers standard cell configurations with solder tags for THT connection, wires and many more. If a customized assembly is required, VARTA can also offer individual battery assembly including solder tags, wires and insulation tape. Please contact your Key Account Manager for more details.

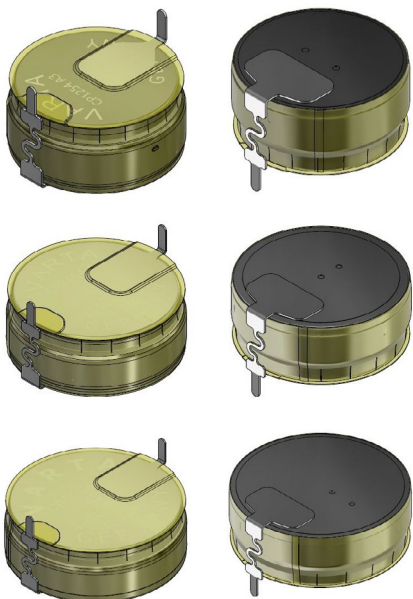

Examples for different battery assemblies

8.2 Multicellular Assembly

If a larger capacity and/or higher discharge currents are required, two or more cells may be connected in a cell pack. These packs can be assembled in various shapes, depending on the customer's requirement. The cells can be also connected in series in order to produce a higher output voltage. Above are shown examples of multicellular configurations of the CoinPower cell.

8.3 Soldering

With assembled tags or wires, the CoinPower battery may be soldered onto a PCB. For this purpose, every tag supplied by VARTA is tin-plated in order to improve its solderability. Please consider the following guidance on the solderability of the CoinPower cell.

Using a Soldering Iron

Do not allow the soldering iron to make direct contact with the body of the cell. Proceed with soldering quickly within 3 seconds while not allowing the temperature of the cell body to exceed 60 °C.

Dip Soldering / Wave Soldering

These two soldering procedures could short circuit the battery. This will cause irreversible damage to the cell. This will impair performance dramatically and might lead to safety risks as well.

Reflow Soldering

NEVER USE REFLOW SOLDERING

During a standard reflow process the temperature on the body and inside the cell will rise to a level which will cause irreversible damage to the cell. This will impair performance dramatically and might lead to safety risks as well.

There is a risk of explosion/bursting and electrolyte leakage during reflow soldering due to excessive temperatures.

9. Application check list

Application check list

In order to find the best possible energy solution for your application, VARTA Microbattery needs certain information.

Please contact us on our website
(<https://www.varta-ag.com/en/industry/service/contact>)
or get in direct contact with your Key Account Manager.

10. Glossary

Glossary

OEM (Original Equipment Manufacturer)

is a broad term whose meaning has evolved over time. In the past, OEM referred to the company that originally built a given product, which was then sold to other companies to rebrand and resell. Over time, however, the term is more frequently used to describe those companies in the business of rebranding a manufacturer's products and selling them to end customers.

Battery

One or more electrochemical cells electrically connected in an appropriate series/parallel arrangement to provide the required operating voltage and current levels including, if any, monitors, controls and other ancillary components (fuses, diodes), case, terminals and markings.

Cell

The basic electrochemical unit providing a source of electrical energy by direct conversion of chemical energy. The cell consists of an assembly of electrodes, separators, electrolyte, container and terminals

Secondary battery

Battery that can be reused after it is charged. There are Ni-Cd and Ni-MH rechargeable carbon batteries in addition to Li-Ion rechargeable battery.

Primary battery

is a battery that is designed to be used once and discarded, and not recharged with electricity and reused like a secondary cell.

Separator

A microporous thin film inserted between cathode and anode to prevent short-circuits and maintain spacing. Polyethylene film, polypropylene film, or other film is used.

Cathode

An electrode at higher potential than the anode, passing electric current to the outside circuit during discharge.

Anode

An electrode at lower potential than the cathode, into which current flows from an external circuit during cell discharge.

Open circuit voltage (OCV)

The voltage of the battery when it is disconnected electrically from outside circuits.

Closed circuit voltage (CCV)

The voltage of the battery when it is connected electrically to an outside circuit.

Nominal Capacity

Capacity used to represent a battery capacity. Usually means capacity in ampere hours, indicated by Ah or mAh.

Nominal Voltage

The nominal voltage of a battery is a measure of the expected voltage of a battery or cell over its entire discharge cycle. The nominal voltage of Coin Power is 3.7 V.

Cycle Life

The number of cycles under specified conditions which are available from a secondary battery before it fails to meet specified criteria as to performance.

Cut off voltage

The limiting voltage which terminates discharge. This voltage generally corresponds to the lower usable voltage limit.

Self-discharge

When battery capacity declines without current flowing to an outside circuit

Energy Density

The amount of energy that can be extracted per unit battery weight, or per unit battery volume. Expressed in units of Wh/kg or Wh/l.

Overcharge

Charging the battery after it has reached the fully-charged state. If a battery is overcharged, Lithium metal is precipitated on the anode surface, and the battery becomes extremely chemically unstable.

Overdischarge

Discharging the battery after the voltage has fallen below the specified cutoff voltage. If a battery is over discharged, the anode current collector copper is dissolved.

Lithium-Ion Charger (CCCV)

Li-Ion batteries commonly require a constant current, constant voltage (CCCV) type of charging algorithm. In other words, a Li-Ion battery should be charged at a constant set current level until it reaches its final voltage. At this point, the charger circuitry should switch over to constant voltage mode, and provide the current necessary to hold the battery at this final voltage (typically 4.2 V per cell). Thus, the charger must be capable of providing stable control loops for maintaining either current or voltage at a constant value, depending on the state of the battery.

PCM

Protection Circuit Module is a device to protect a battery against risk of abnormal events such as over-discharge, overcharge, or short circuit.

PCB

A printed circuit board (PCB) mechanically supports and electrically connects electronic components using conductive tracks, pads and other features etched from copper sheets laminated onto a non-conductive substrate.

THT connection

Through-hole technology, also spelled „thru-hole“, refers to the mounting scheme used for electronic components that involves the use of leads on the components that are inserted into holes drilled in printed circuit boards (PCB) and soldered to pads on the opposite side either by manual assembly (hand placement) or by the use of automated insertion mount machines

SMD connection

SMD (surface-mount device) is an electronic device whose components are placed or mounted onto the surface of the printed circuit board (PCB). This method of manufacturing electronic circuit boards is based on the surface-mount technology (SMT), which has largely replaced the through-hole technology (THT) especially in devices that need to be small or flat.

Contact

Headquarters

VARTA Microbattery GmbH
VARTA-Platz 1,
73479 Ellwangen, Germany
Tel +49 7961 921-0
Fax +49 7961 921-2553

Asia Pacific

VARTA Microbattery Pte. Ltd.
300 Tampines Avenue 5,
#05-01 Income
@ Tampines Junction,
529653 Singapore
Tel +65 6 260 58 01
Fax +65 6 260 59 60

Japan

VARTA Microbattery Japan K.K.
Kyobashi Y'SUS Bldg,
3F.1-6-12, Kyobashi, Chuo-Ku
Tokyo 104-0031, Japan
Tel +81 3 35 67 81 71
Fax +81 3 35 67 81 75

China

VARTA Competence Center Shenzhen
EMEA Consumer Batteries (Shenzhen) Co. Ltd.
No. 1003 Forsafe Technology Building B,
13 GaoXinSouth 1st Rd. Hi-tech Industrial Park,
Nanshan District, Shenzhen City, China
Tel: +86 755 3397 4791

Taiwan

VARTA Microbattery Pte. Ltd.
3F No.85, Xinhu 1st Road,
Neihu District Taipei City 114, Taiwan
Tel +886 2 27 90 29 92

Hong Kong

VARTA Microbattery Pte. Ltd.
Room 1702-3, 17/F Fullerton Centre
19 Hung to Road, Kwun Tong
Kowloon, Hongkong
Tel +852 28 98 83 73
Fax +852 28 97 76 09

USA

VARTA Microbattery Inc.
555 Theodore Fremd Avenue,
Suite C 304 Rye, NY 10580, USA
Tel +1 914 592 25 00
Fax +1 914 345 04 88

Representations and distributors in all major countries worldwide. Please see webpage.

 www.linkedin.com/showcase/varta-microbatteries

 www.youtube.com/VARTAMicrobatteryGmbH

VARTA Microbattery GmbH is a company of VARTA AG.

www.varta-ag.com